

Gross Error Detection in Chemical Plants and Refineries for On-Line Optimization

Xueyu Chen, Derya B. Ozyurt and Ralph W. Pike

Louisiana State University

Baton Rouge, Louisiana

Thomas A. Hertwig

IMC Agrico Company

Convent, Louisiana

Jack R. Hopper and Carl L. Yaws

Lamar University

Beaumont, Texas

Workshop on Systems Safety, LAWSS 2003, Jorge A. Aravena, Workshop Program Chair,
sponsored by NSF and NASA, Baton Rouge, LA (February 28, 2003)

INTRODUCTION

- o Status of on-line optimization
- o Theoretical evaluation of distribution functions used in NLP's
- o Numerical results support the theoretical evaluation
- o An optimal procedure for on-line optimization
- o Application to a Monsanto contact process
- o Interactive Windows program incorporating these methods

Mineral Processing Research Institute
web site
www.mpri.lsu.edu

On-Line Optimization

Automatically adjust operating conditions with the plant's distributed control system

Maintains operations at optimal set points

Requires the solution of three NLP's

gross error detection and data reconciliation
parameter estimation
economic optimization

BENEFITS

Improves plant profit by 3-5%

Waste generation and energy use are reduced

Increased understanding of plant operations

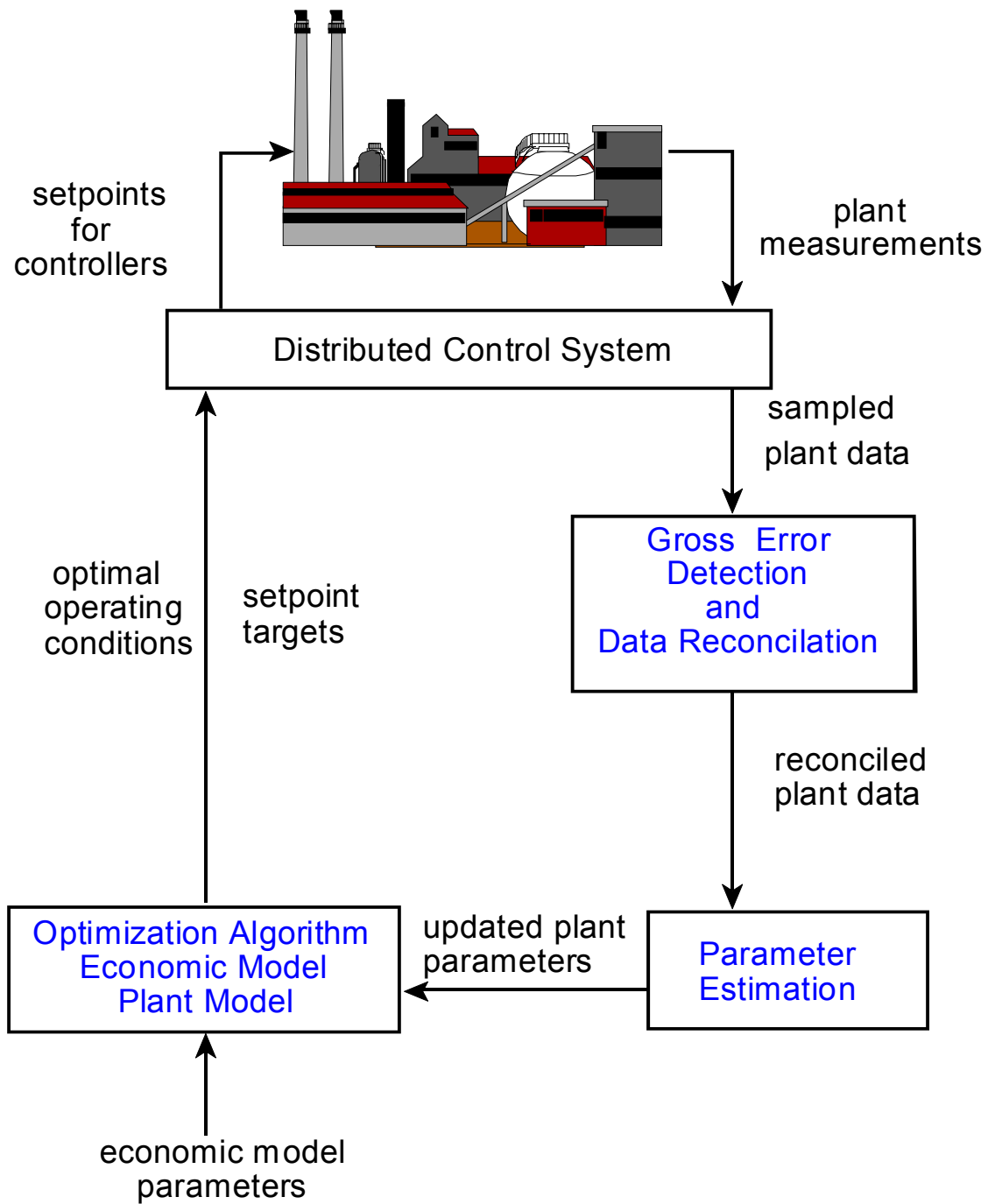

Some Companies Using On-Line Optimization

United States

Texaco
Amoco
Conoco
Lyondel
Sunoco
Phillips
Marathon
Dow
Chevron
Pyrotec/KTI
NOVA Chemicals (Canada)
British Petroleum

Europe

OMV Deutschland
Dow Benelux
Shell
OEMV
Penex
Borealis AB
DSM-Hydrocarbons

Applications

mainly crude units in refineries and ethylene plants

Companies Providing On-Line Optimization

Aspen Technology - Aspen Plus On-Line

- DMC Corporation
- Setpoint
- Hyprotech Ltd.

Simulation Science - ROM

- Shell - Romeo

Profimatics - On-Opt

- Honeywell

Litwin Process Automation - FACS

DOT Products, Inc. - NOVA

Distributed Control System

Runs control algorithm three times a second

Tags - contain about 20 values for each measurement, e.g. set point, limits, alarm

Refinery and large chemical plants have 5,000 - 10,000 tags

Data Historian

Stores instantaneous values of measurements for each tag every five seconds or as specified.

Includes a relational data base for laboratory and other measurements not from the DCS

Values are stored for one year, and require hundreds of megabites

Information made available over a LAN in various forms, e.g. averages, Excel files.

Plant Problem Size

	Contact	Alkylation	Ethylene
Units	14	76	-
Streams	35	110	~4,000
Constraints			
Equality	761	1579	~400,000
Inequality	28	50	~10,000
Variables			
Measured	43	125	~300
Unmeasured	732	1509	~10,000
Parameters	11	64	~100

Status of Industrial Practice for On-Line Optimization

Steady state detection by time series screening

Gross error detection by time series screening

Data reconciliation by least squares

Parameter estimation by least squares

Economic optimization by standard methods

Key Elements

Gross Error Detection

Data Reconciliation

Parameter Estimation

Economic Model
(Profit Function)

Plant Model
(Process Simulation)

Optimization Algorithm

DATA RECONCILIATION

Adjust process data to satisfy material and energy balances.

Measurement error - **e**

$$\mathbf{e} = \mathbf{y} - \mathbf{x}$$

y = measured process variables

x = true values of the measured variables

$$\tilde{\mathbf{x}} = \mathbf{y} + \mathbf{a}$$

a - measurement adjustment

DATA RECONCILIATION

measurements having only random errors - least squares

$$\text{Minimize: } \mathbf{e}^T \Sigma^{-1} \mathbf{e} = (\mathbf{y} - \mathbf{x})^T \Sigma^{-1} (\mathbf{y} - \mathbf{x})$$

$$\text{Subject to: } \mathbf{f}(\mathbf{x}) = 0$$

Σ = variance matrix = $\{\sigma^2_{ij}\}$.

σ_i = standard deviation of e_i .

$\mathbf{f}(\mathbf{x})$ - process model
- linear or nonlinear

DATA RECONCILIATION

Linear Constraint Equations - material balances only

$$\mathbf{f}(\mathbf{x}) = \mathbf{Ax} = 0$$

analytical solution - $\tilde{\mathbf{x}} = \mathbf{y} - \Sigma \mathbf{A}^T (\mathbf{A} \Sigma \mathbf{A}^T)^{-1} \mathbf{Ay}$

Nonlinear Constraint Equations

$\mathbf{f}(\mathbf{x})$ includes material and energy balances, chemical reaction rate equations, thermodynamic relations

nonlinear programming problem

GAMS and a solver, e.g. MINOS

Types of Gross Errors

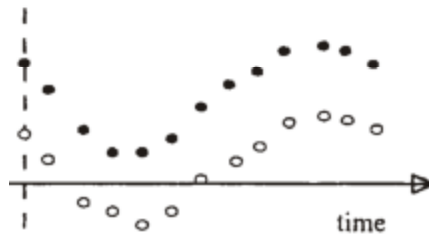
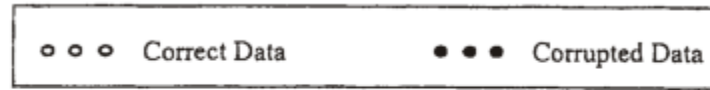

(a) Bias

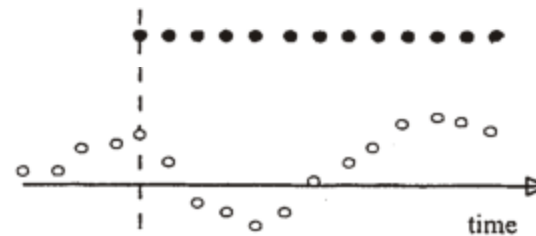

(b) Complete Failure

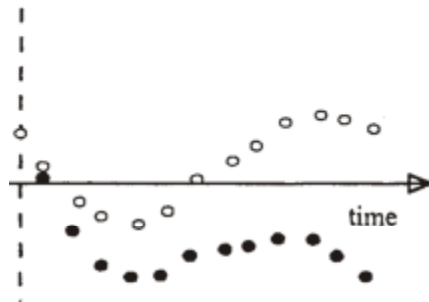

(c) Drifting

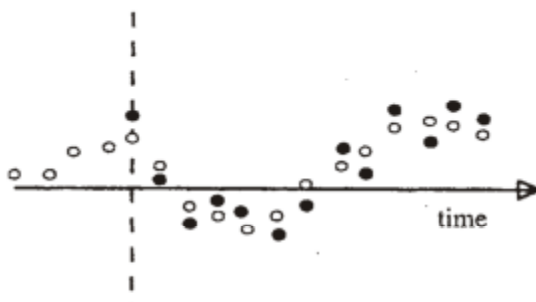

(d) Precision Degradation

Source: S. Narasimhan and C. Jordache, *Data Reconciliation and Gross Error Detection*, Gulf Publishing Company, Houston, TX (2000)

Gross Error Detection Methods

Statistical testing

- o many methods
- o can include data reconciliation

Others

- o Principal Component Analysis
- o Ad Hoc Procedures - Time series screening

Combined Gross Error Detection and Data Reconciliation

Measurement Test Method - least squares

$$\text{Minimize: } (\mathbf{y} - \mathbf{x})^T \Sigma^{-1} (\mathbf{y} - \mathbf{x}) = \mathbf{e}^T \Sigma^{-1} \mathbf{e}$$

\mathbf{x}, \mathbf{z}

$$\text{Subject to: } \mathbf{f}(\mathbf{x}, \mathbf{z}, \boldsymbol{\theta}) = 0$$

$$\mathbf{x}^L \leq \mathbf{x} \leq \mathbf{x}^U$$

$$\mathbf{z}^L \leq \mathbf{z} \leq \mathbf{z}^U$$

Test statistic:

if $|e_i|/\sigma_i \geq C$ measurement contains a gross error

Least squares is based on only random errors being present

Gross errors cause numerical difficulties

Need methods that are not sensitive to gross errors

Methods Insensitive to Gross Errors

Tjao-Biegler's Contaminated Gaussian Distribution

$$P(y_i | x_i) = (1-\eta)P(y_i | x_i, R) + \eta P(y_i | x_i, G)$$

$P(y_i | x_i, R)$ = probability distribution function for the random error

$P(y_i | x_i, G)$ = probability distribution function for the gross error.

Gross error occur with probability η

Gross Error Distribution Function

$$P(y|x, G) = \frac{1}{\sqrt{2\pi}b\sigma} e^{-\frac{(y-x)^2}{2b^2\sigma^2}}$$

Tjao-Biegler Method

Maximizing this distribution function of measurement errors or minimizing the negative logarithm subject to the constraints in plant model, i.e.,

$$\text{Minimize: } \mathbf{x} \quad -\sum_i \left\{ \ln \left[(1-\eta) e^{-\frac{(y_i-x_i)^2}{2\sigma_i^2}} + \frac{\eta}{b} e^{-\frac{(y_i-x_i)^2}{2b^2\sigma_i^2}} \right] - \ln[\sqrt{2\pi}\sigma_i] \right\}$$

Subject to: $\mathbf{f}(\mathbf{x}) = 0$ plant model
 $\mathbf{x}^L \leq \mathbf{x} \leq \mathbf{x}^U$ bounds on the process variables

A NLP, and values are needed for η and b

Test for Gross Errors

If $\eta P(y_i | x_i, G) \geq (1-\eta) P(y_i | x_i, R)$, gross error
probability of a gross error probability of a random error

$$|\epsilon_i| = \left| \frac{y_i - x_i}{\sigma_i} \right| > \sqrt{\frac{2b^2}{b^2-1} \ln \left[\frac{b(1-\eta)}{\eta} \right]}$$

Robust Function Methods

$$\begin{aligned} \text{Minimize:} & \quad -\sum_i [\rho(y_i, x_i)] \\ \mathbf{x} & \\ \text{Subject to:} & \quad \mathbf{f}(\mathbf{x}) = 0 \\ & \quad \mathbf{x}^L \leq \mathbf{x} \leq \mathbf{x}^U \end{aligned}$$

Lorentzian distribution

$$\rho(\epsilon_i) = \frac{1}{1 + \frac{1}{2}\epsilon_i^2}$$

Fair function

$$\rho(\epsilon_i, c) = c^2 \left[\frac{|\epsilon_i|}{c} - \log \left(1 + \frac{|\epsilon_i|}{c} \right) \right]$$

c is a tuning parameter

Test statistic

$$\epsilon_i = (y_i - x_i) / \sigma_i$$

Parameter Estimation Error-in-Variables Method

Least squares

$$\text{Minimize: } (\mathbf{y}_- \mathbf{x})^T \Sigma^{-1} (\mathbf{y}_- \mathbf{x}) = \mathbf{e}^T \Sigma^{-1} \mathbf{e}$$

θ

$$\text{Subject to: } \mathbf{f}(\mathbf{x}, \theta) = 0$$

θ - p | ant parameters

Simultaneous data reconciliation and parameter estimation

$$\text{Minimize: } (\mathbf{y}_- \mathbf{x})^T \Sigma^{-1} (\mathbf{y}_- \mathbf{x}) = \mathbf{e}^T \Sigma^{-1} \mathbf{e}$$

\mathbf{x}, θ

$$\text{Subject to: } \mathbf{f}(\mathbf{x}, \theta) = 0$$

another nonlinear programming problem

Three Similar Optimization Problems

Optimize: **Objective function**
Subject to: **Constraints are the plant model**

Objective function

data reconciliation - distribution function
parameter estimation - least squares
economic optimization - profit function

Constraint equations

material and energy balances
chemical reaction rate equations
thermodynamic equilibrium relations
capacities of process units
demand for product
availability of raw materials

Theoretical Evaluation of Algorithms for Data Reconciliation

Determine sensitivity of distribution functions to gross errors

Objective function is the product or sum of distribution functions for individual measurement errors

$$P = \prod p(\epsilon) \propto \sum \ln p(\epsilon) \propto \sum \rho(\epsilon)$$

Three important concepts in the theoretical evaluation of the robustness and precision of an estimator from a distribution function

Influence Function

Robustness of an estimator is unbiasedness (insensitivity) to the presence of gross errors in measurements. The sensitivity of an estimator to the presence of gross errors can be measured by the influence function of the distribution function. For M-estimate, the influence function is defined as a function that is proportional to the derivative of a distribution function with respect to the measured variable, $(\partial\rho/\partial x)$

Relative Efficiency

The precision of an estimator from a distribution is measured by the relative efficiency of the distribution. The estimator is precise if the variation (dispersion) of its distribution function is small

Breakdown Point

The break-down point can be thought of as giving the limiting fraction of gross errors that can be in a sample of data and a valid estimation of the estimator is still obtained using this data. For repeated samples, the break-down point is the fraction of gross errors in the data that can be tolerated and the estimator gives a meaningful value.

Influence Function

proportional to the derivative of the distribution function, $IF \propto \partial p / \partial x$

represents the sensitivity of reconciled data to the presence of gross errors

Normal Distribution

$$IF_{MF} \propto \frac{\partial p_i}{\partial x_i} = \frac{y_i - x_i}{\sigma_i^2} = \frac{\varepsilon_i}{\sigma_i}$$

Contaminated Gaussian Distribution

$$IF_{\infty} \frac{\partial p_i}{\partial x_i} = \frac{\frac{\varepsilon_i}{\sigma_i} \left\{ (1-\eta) e^{-\frac{\varepsilon_i^2}{2} \left(1 + \frac{1}{b^2}\right) + \frac{\eta}{b^3}} \right\}}{(1-\eta) e^{-\frac{\varepsilon_i^2}{2} \left(1 + \frac{1}{b^2}\right) + \frac{\eta}{b}}}$$

Lorentzian Distribution

$$IF_{Lorentzian} \propto \frac{\partial p_i}{\partial \varepsilon_i} = -\frac{\varepsilon_i}{\left(1 + \frac{1}{2}\varepsilon_i^2\right)^2}$$

Fair Function

$$IF_{Fair} \propto \frac{\partial p_i}{\partial \varepsilon_i} = c^2 \left(\frac{1}{c} - \frac{\frac{1}{c}}{1 + \frac{|\varepsilon_i|}{c}} \right) = \frac{1}{\frac{1}{|\varepsilon_i|} + \frac{1}{c}}$$

Comparison of Influence Functions

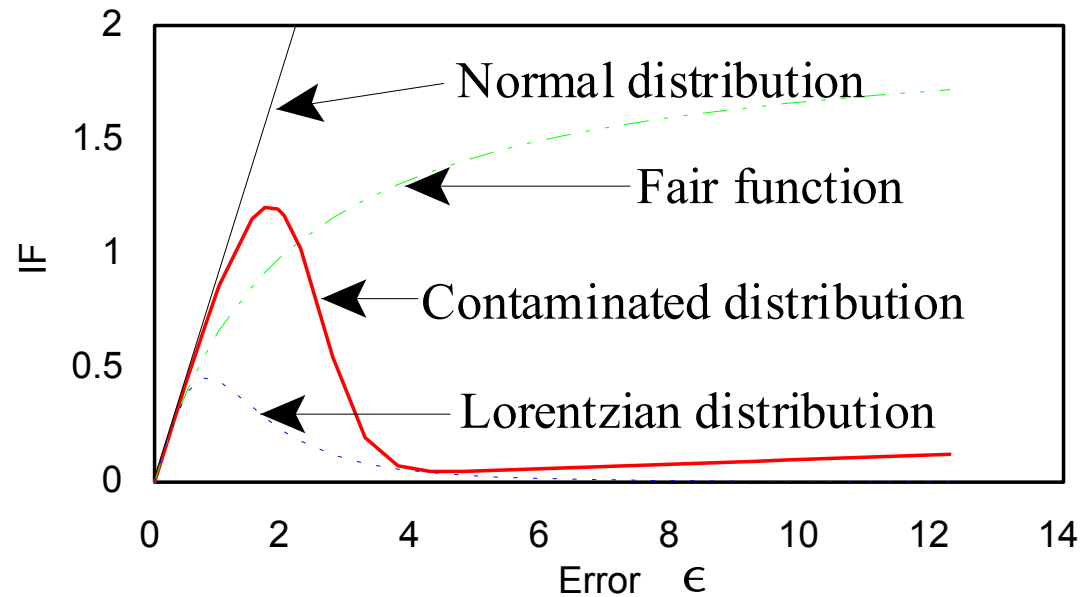

Effect of Gross Errors on Reconciled Data - Least to Most

Lorentzian ▶ Contaminated Gaussian ▶ Fair ▶ Normal

Air Inlet	Air Dryer	Main Compressor	Sulfur Burner	Waste Heat Boiler	Super-Heater	SO ₂ to SO ₃ Converter	Hot & Cold Gas to Gas Heat EX.	Heat Economizers	Final & Interpass Towers
-----------	-----------	-----------------	---------------	-------------------	--------------	--	--------------------------------	------------------	--------------------------

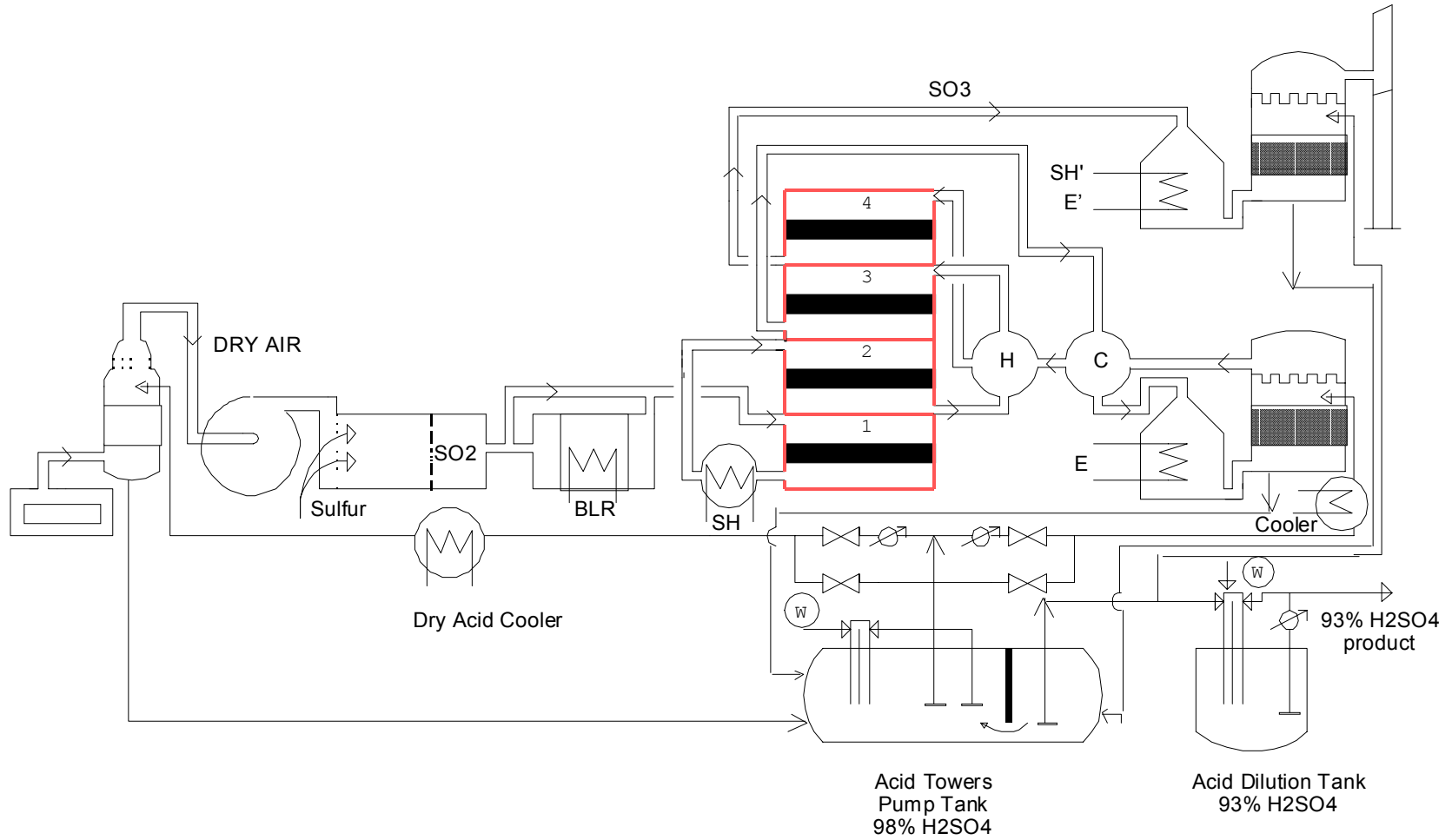

Numerical Evaluation of Algorithms

Simulated plant data is constructed by

$$\mathbf{y} = \mathbf{x} + \mathbf{e} + a\delta$$

\mathbf{y} - simulated measurement vector for measured variables

\mathbf{x} - true values (plant design data) for measured variables

\mathbf{e} - random errors added to the true values

a - magnitude of a gross error added to one of measured variables

δ - a vector with one in one element corresponding to the measured variable with gross error and zero in other elements

Criteria for Numerical Evaluation

Gross error detection rate - ratio of number of gross errors that are correctly detected to the total number of gross errors in measurements

Number of type I errors - If a measurement does not contain a gross error and the test statistic identifies the measurement as having a gross error, it is called a type I error

Random and gross error reduction - the ratio of the remaining error in the reconciled data to the error in the measurement

Comparison of Gross Error Detection Rates 390 Runs for Each Algorithm

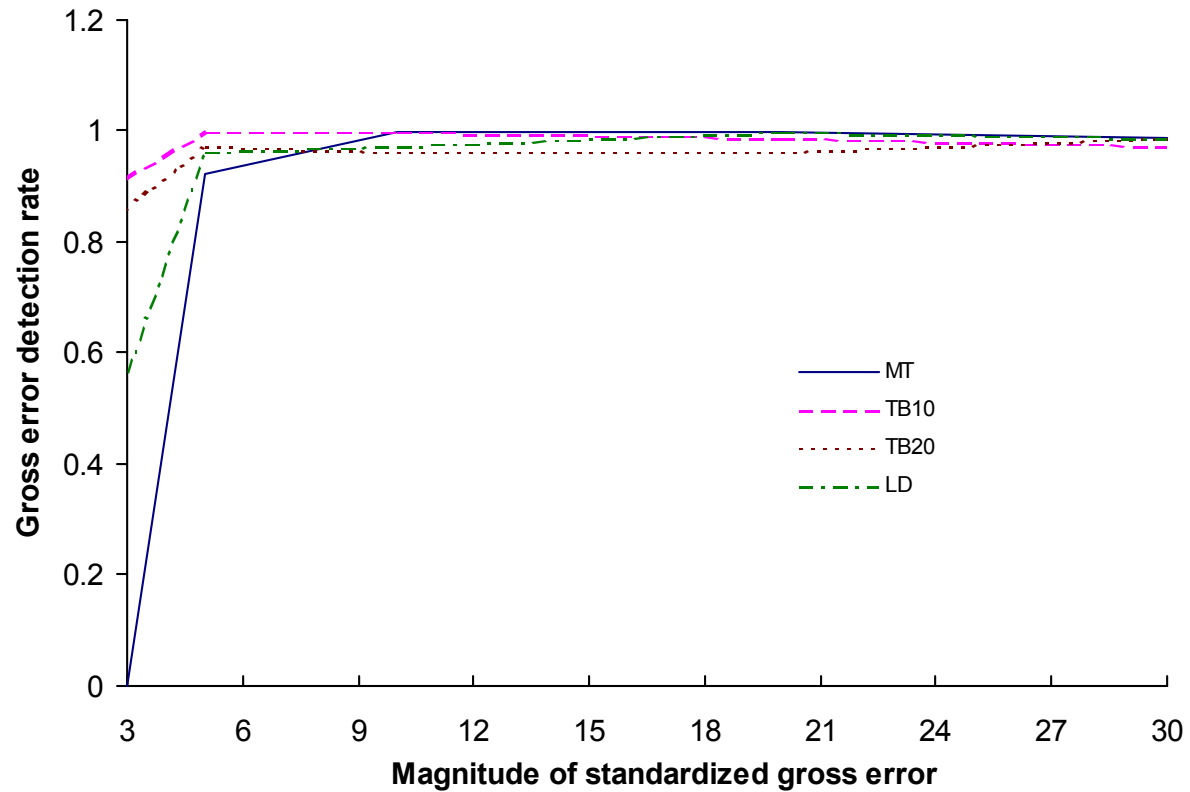

Comparison of Numbers of Type I Errors

390 Runs for Each Algorithm

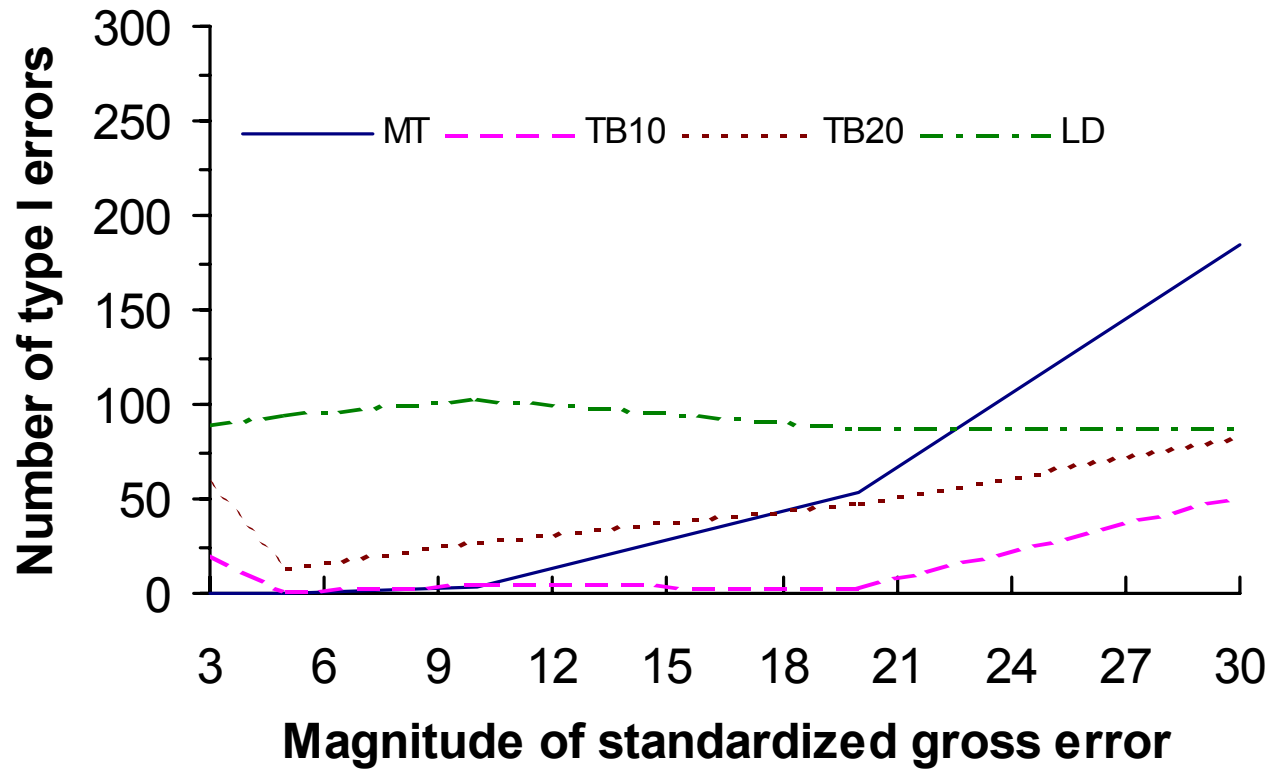

Comparison of Relative Gross Error Reductions 645 Runs for Each Algorithm

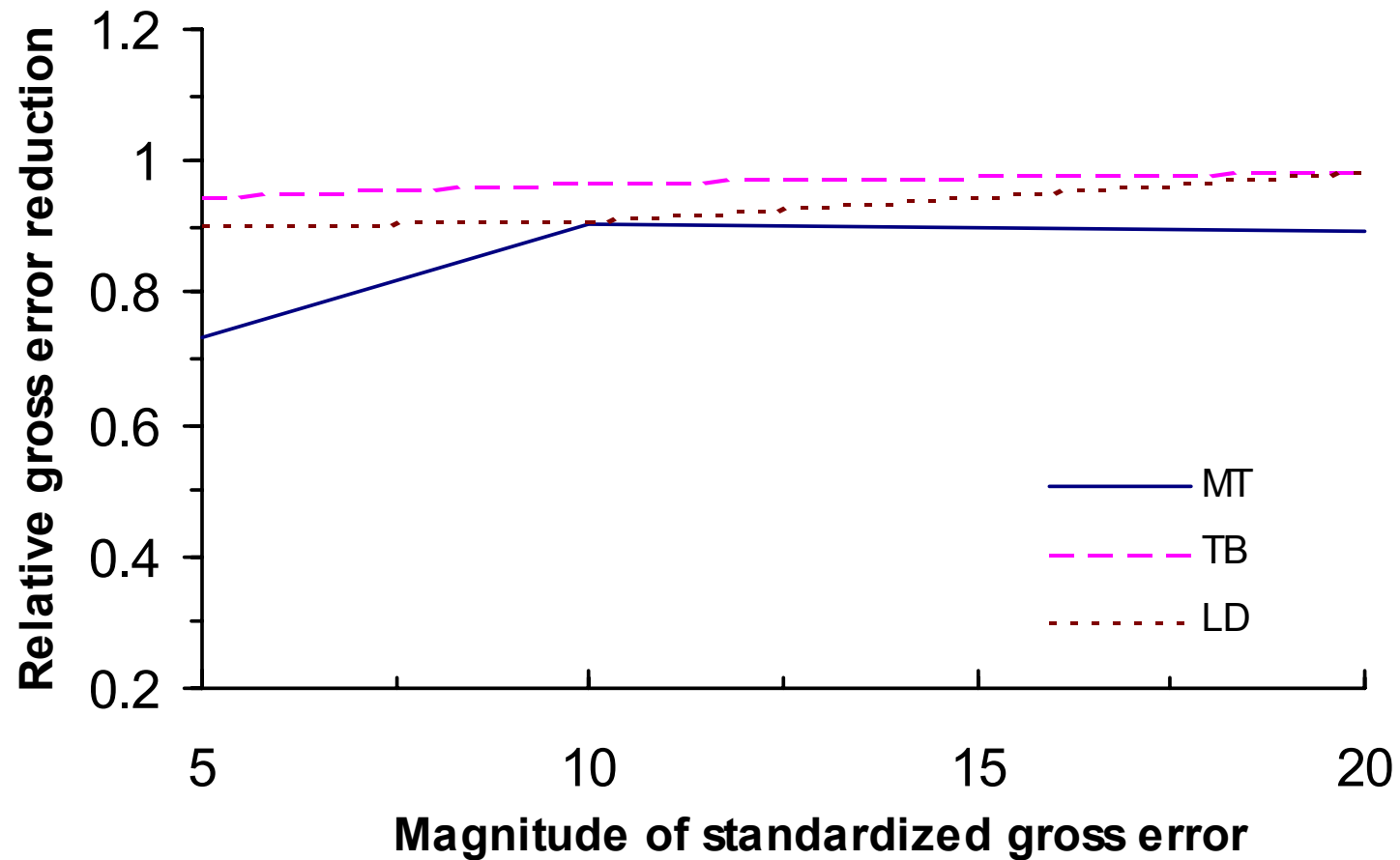

Results of Theoretical and Numerical Evaluations

Tjoa-Biegler's method has the best performance for measurements containing random errors and moderate gross errors (3σ - 30σ)

Robust method using Lorentzian distribution is more effective for measurements with very large gross errors (larger than 30σ)

Measurement test method gives a more accurate estimation for measurements containing only random errors. It gives significantly biased estimation when measurements contain gross errors larger than 10σ

Air Inlet	Air Dryer	Main Compressor	Sulfur Burner	Waste Heat Boiler	Super-Heater	SO ₂ to SO ₃ Converter	Hot & Cold Gas to Gas Heat EX.	Heat Economizers	Final & Interpass Towers
-----------	-----------	-----------------	---------------	-------------------	--------------	--	--------------------------------	------------------	--------------------------

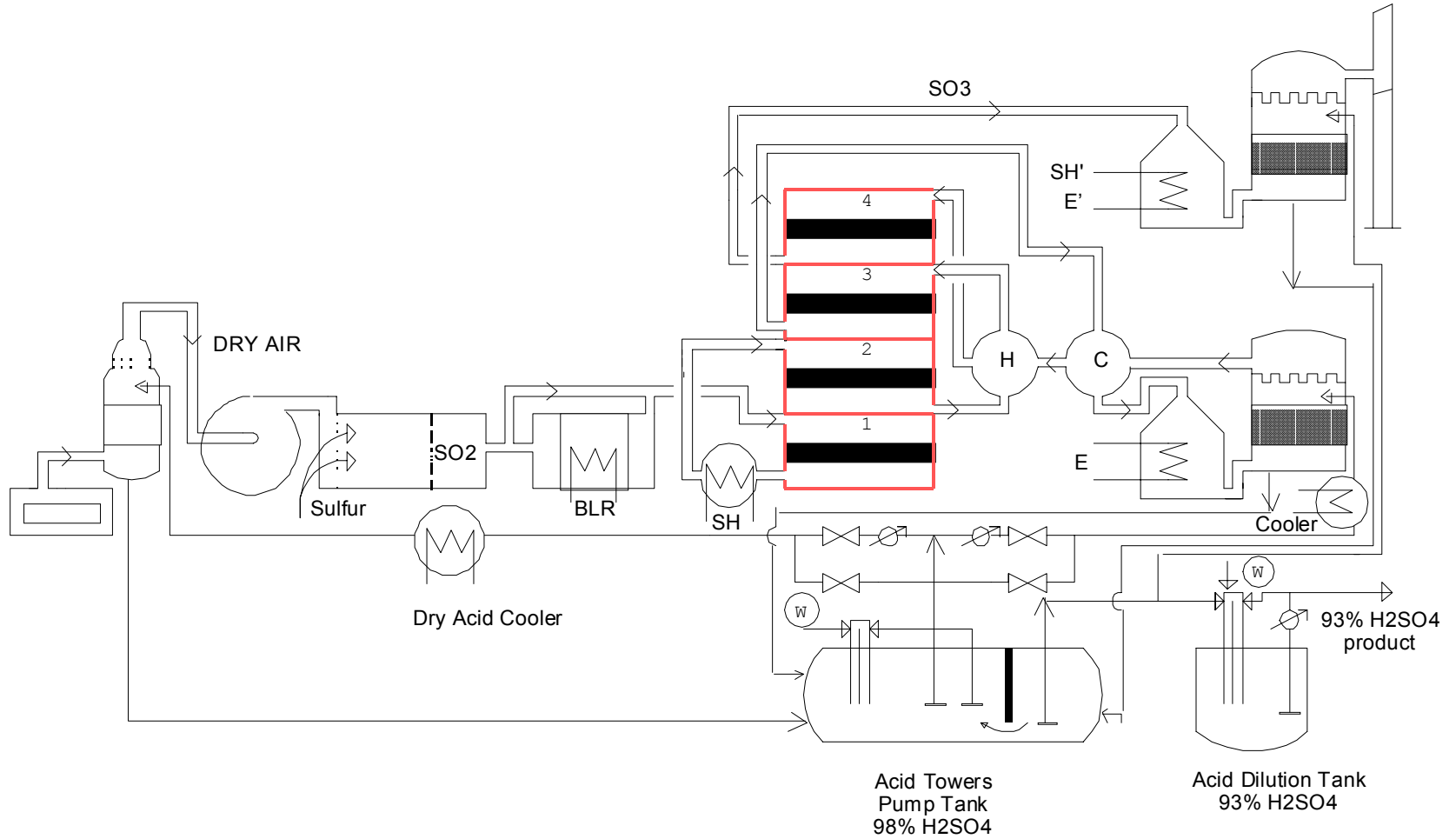

Economic Optimization

Value Added Profit Function

$$s_{F64}F_{64} + s_{FS8}F_{S8} + s_{FS14}F_{S14} - c_{F50}F_{50} - c_{FS1}F_{S1} - c_{F65}F_{65}$$

On-Line Optimization Results

Date	Current (\$/day)	Profit ptimal (\$/day)	Improvement
6-10-97	37,290 ^O	38,146	2.3% \$313,000/yr
6-12-97	36,988	38,111	3.1% \$ 410,000/yr

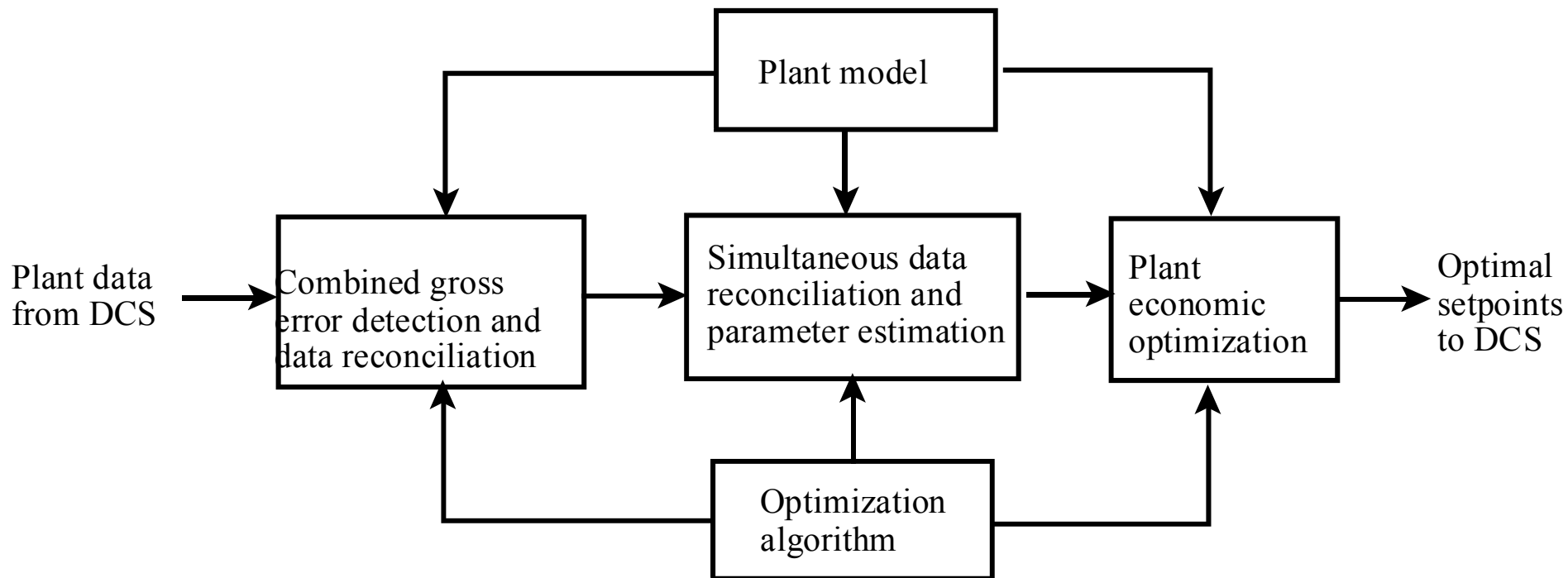

Interactive On-Line Optimization Program

1. Conduct combined gross error detection and data reconciliation to detect and rectify gross errors in plant data sampled from distributed control system using the Tjoa-Biegler's method (the contaminated Gaussian distribution) or robust method (Lorentzian distribution).

This step generates a set of measurements containing only random errors for parameter estimation.

2. Use this set of measurements for simultaneous parameter estimation and data reconciliation using the least squares method.

This step provides the updated parameters in the plant model for economic optimization.

3. Generate optimal set points for the distributed control system from the economic optimization using the updated plant and economic models.

Interactive On-Line Optimization Program

Process and economic models are entered as equations in a form similar to Fortran

The program writes and runs three GAMS programs.

Results are presented in a summary form, on a process flowsheet and in the full GAMS output

The program and users manual (120 pages) can be downloaded from the LSU Minerals Processing Research Institute web site

[URLhttp://www.mpri.lsu.edu](http://www.mpri.lsu.edu)

Instructions

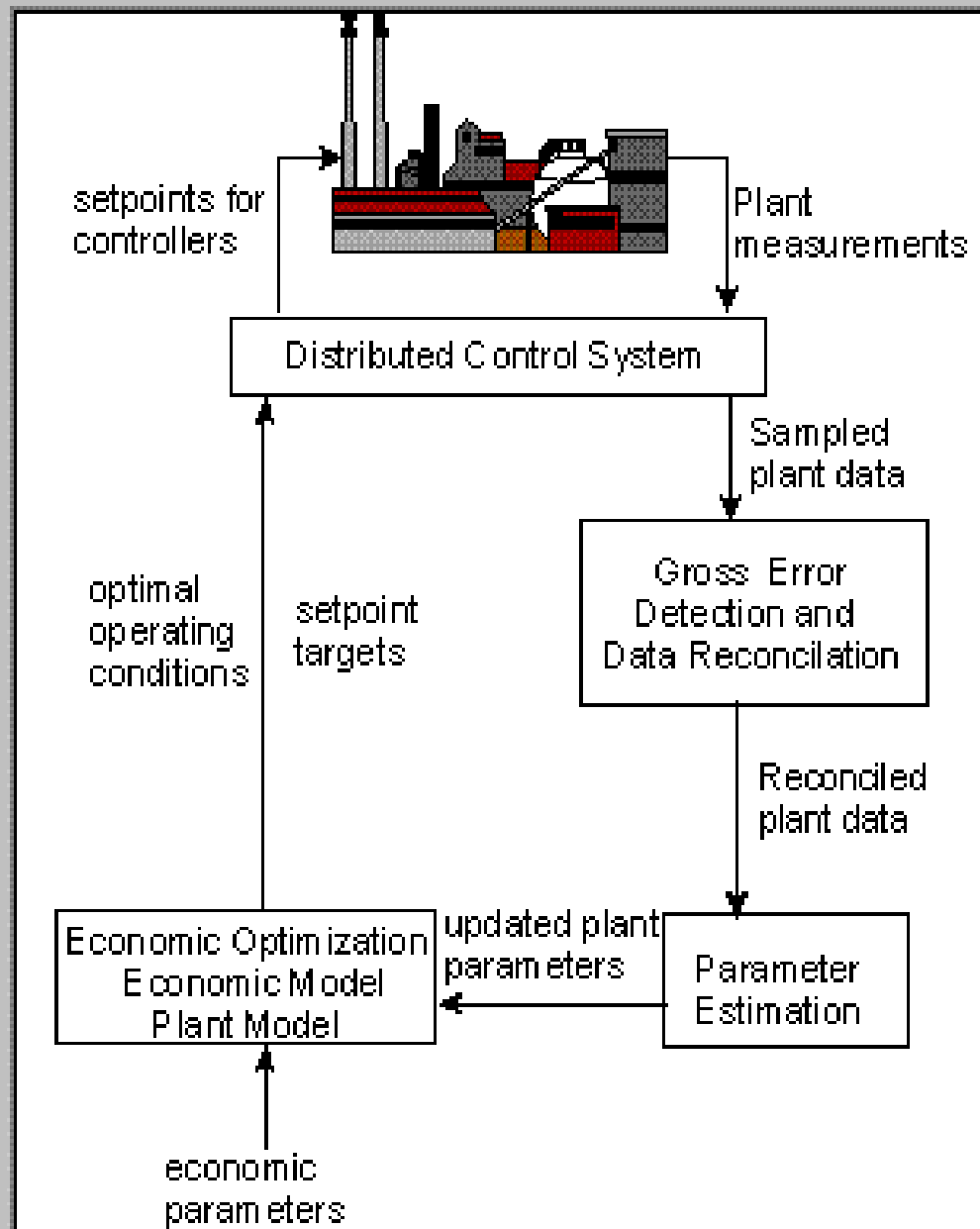

On-line optimization adjusts the operation of a plant to maximize the profits and minimize the emissions by providing the optimal set points of the Distributed Control System (DCS).

Create New Model. Requires:

- a. Plant Model
- b. Economic Model
- c. Parameters
- d. DCS Data

Open Existing Model

Revise Plant Information

OK

Cancel

Help

Do not display this window next time



Model Description	Tables	Measured Variables	Unmeasured Variables	Plant Parameters
Equality Constraints	Inequality Constraints	Optimization Algorithms	Constant Properties	

Data Validation Algorithm: Tjoa-Biegler Method (moderate gross errors)

Parameters Estimation Algorithm: Tjoa-Biegler Method (moderate gross errors)

Economic Optimization Objective Function:
$$-33*crude+0.01965*fgad-2.5*smrf+0.01965*fgf-2.2*srdsc-2.2*srfoc+0.01965*fgcc+$$

Optimization Direction: Maximizing

Economic Model Type: Linear

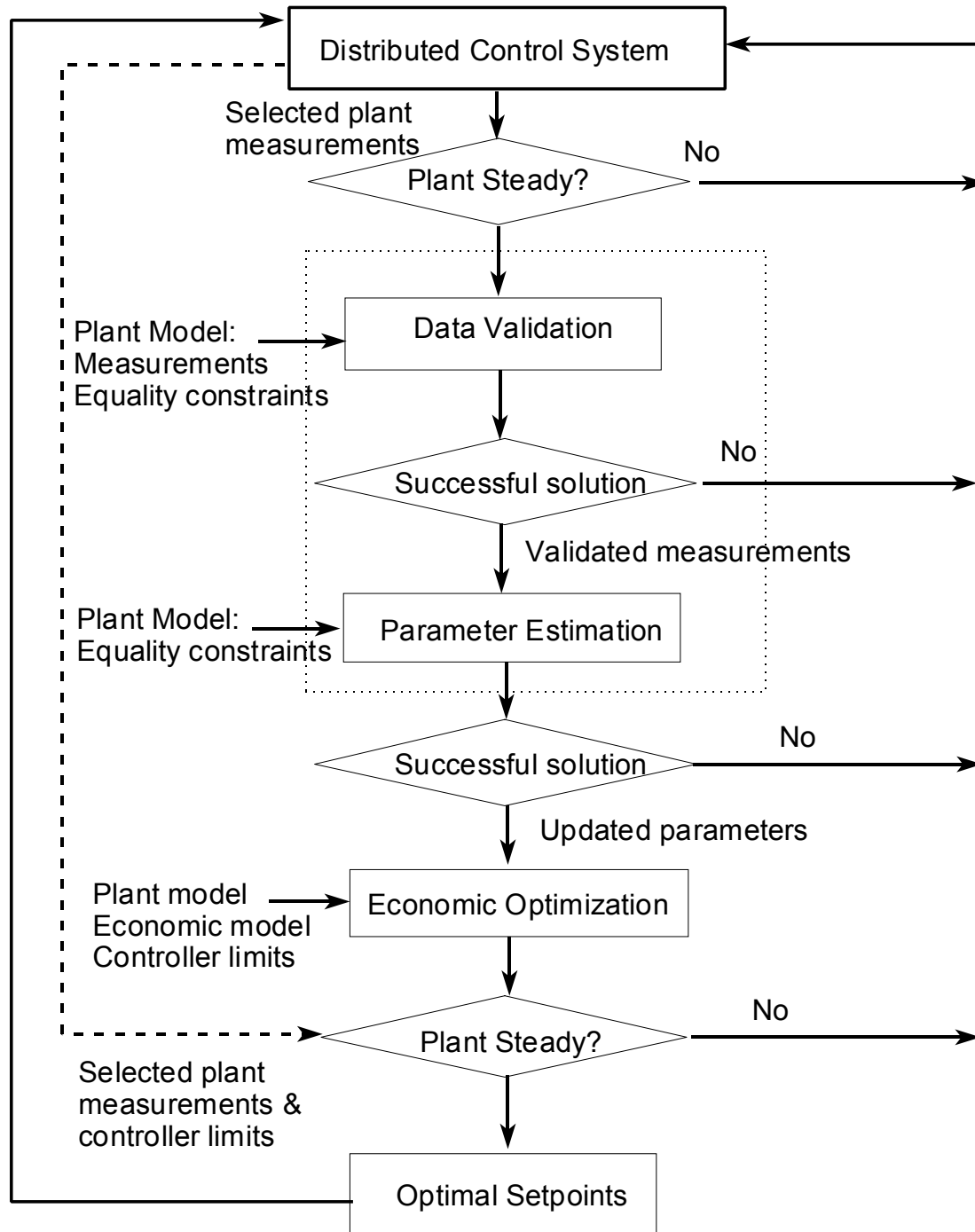

Some Other Considerations

Redundancy

Observeability

Variance estimation

Closing the loop

Dynamic data reconciliation
and parameter estimation

Summary

Most difficult part of on-line optimization is developing and validating the process and economic models.

Most valuable information obtained from on-line optimization is a more thorough understanding of the process

Acknowledgments

Support from

Gulf Coast Hazardous
Substance Research Center

Environmental Protection
Agency

Department of Energy